

Example

1. ZID\_2 PR 1

**Cantilever concrete wall**

( EC2 EN1992-1-1:2004, EC0 EN1990:2002, EC7 EN1997-1-1:2004, EC8 EN1998-5:2004, )

C25/30 - B500B

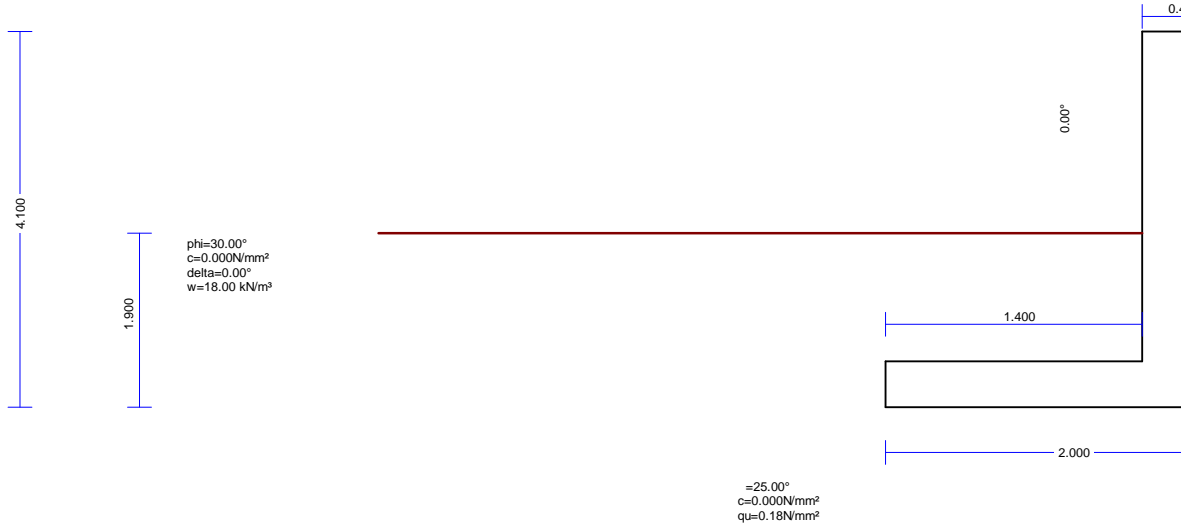

1.1. Wall properties-Parameters-Code requirements

**Dimensions**

Height of wall	h= 4.100 m
Transverse length of wall	L= 6.000 m
Steam thickness at top	B1= 0.400 m
Steam thickness at bottom	B2= 0.400 m
Width of wall base	B= 2.000 m
Width of wall toe	1.400 m
Width of wall heel	0.200 m
Height of wall steam	3.600 m
Thickness of wall footing	0.500 m
Front thickness of wall toe	0.500 m
Back thickness of wall heel	0.500 m
Slope (batter) at frontface	0.000° (0:1)
Slope (batter) at backface	0.000° (0:1)

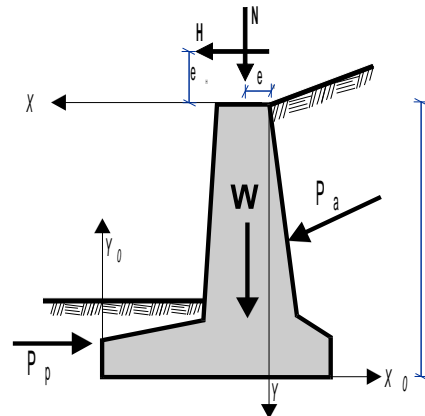

**Weight of wall**

Unit weight of wall material	g=25.000 kN/m³
Cross section area of wall	A= 2.440 m²
Self weight per meter of wall	W= 2.440x25.000= 61.00 kN/m
Center of gravity of wall at	x=0.446 m, y=2.640 m (xo=1.354 m, yo=1.460 m)

**Wall materials**

Steam : Concrete-Steel class: C25/30-B500B (EN1992-1-1, §3)  
 : Concrete cover: Cnom=25 mm (EN1992-1-1, §4.4.1)  
 Footing : Concrete-Steel class: C25/30-B500B  
 : Concrete cover: Cnom=75 mm

**Weight of backfill**

Weight of backfill per meter Ws=12.96 kN/m  
 Center of gravity of backfill x=-0.100 m, y=1.800 m

**1.2. Partial factors for actions and soil properties** (EC7 Tables A.1-A.4, EC8-5 §3.1)

Equilibrium limit state (EQU), Structural limit state (STR), Geotechnical limit state (GEO)

Actions		(EQU)	(STR)	(GEO)
Permanent Unfavourable	Gdst:	1.10	1.35	1.00
Permanent Favourable	Gstb:	0.90	1.00	1.00
Variable Unfavourable	Qdst:	1.50	1.50	1.30
Variable Favourable	Qstb:	0.00	0.00	0.00

Soil parameters				
Angle of shearing resistance	:	1.25	1.00	1.25
Effective cohesion	c:	1.25	1.00	1.25
Undrained shear strength	cu:	1.40	1.00	1.40
Unconfined strength	qu:	1.40	1.00	1.40
Weight density	w:	1.00	1.00	1.00

**1.3. Properties of foundation soil**

Bearing capacity of foundation soil qu=0.18 N/mm<sup>2</sup>  
 Friction angle between wall footing and soil =25.00°, friction coefficient tan( )=0.466  
 Cohesion between wall footing and soil c=0.000 N/mm<sup>2</sup>

**1.4. Computation of active earth pressure (Coulomb theory)**

**1.4.1. Wall part from y=0.000 m to y=4.100 m, Hs=4.100 m**

Top point A x= 0.000 m y= 0.000 m  
 Bottom point B x= 0.000 m y= 4.100 m

**Soil properties**

Soil type : Dense sand  
 Unit weight of soil =18.00 kN/m<sup>3</sup>  
 Unit weight of soil (saturated) s=18.00 kN/m<sup>3</sup>  
 Unit weight of water w=10.00 kN/m<sup>3</sup>  
 Angle of shearing resistance of ground =30.00°  
 Cohesion of ground c=0.000 N/mm<sup>2</sup>  
 Slope angle of ground surface = 0.00°  
 Inclination angle of the wall backface = 0.00°  
 Angle of shear resist. between ground-wall =17.50°

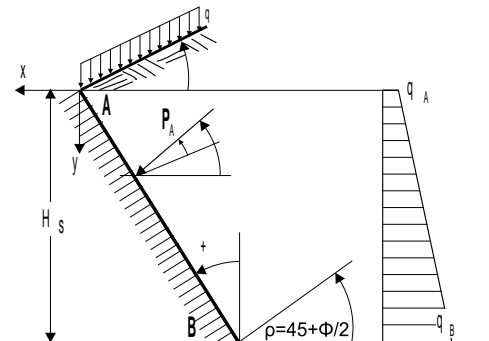

**Earth pressure according to Coulomb theory**

	EQU	STR	GEO
Angle of rupture plane =45°+ /2	= 57.00	60.00	57.00°
Coefficient of active earth pressure Ka=	0.378	0.299	0.378
Earth pressure q(y)=qA+ ·y·Ka			

$$K_A = \frac{\cos^2(-)}{\cos^2 \cos(+)} \left[ 1 + \frac{\sin(+)\sin(-)}{\cos(+)\cos(-)} \right]^2$$

**Permanent actions**

	EQU	STR	GEO
Earth pressure at the top (y=yA)	qA= 0.00	0.00	0.00 kN/m <sup>2</sup>
Earth pressure at the bottom (y=yA+ 4.10m)	qB= 27.90	22.07	27.90 kN/m <sup>2</sup>
Earth force Pa=½(qA+qB)H	Pa= 57.19	45.24	57.19 kN/m
Angle of earth force	= 14.00	17.50	14.00 °
Earth force in x direction	Pax= 54.54	43.15	54.54 kN/m
Earth force in y direction	Pay= 17.20	13.60	17.20 kN/m
Moment of earth force at top point (x=0,y=0)	M = -149.06-117.93-149.06 kNm/m		
Point of application of earth force	x= 0.000 m, y= 2.733 m		

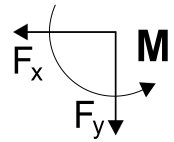

**Total forces and moments**

Forces and moments at bottom point B (x=0.000 m, y=4.100 m)

**Permanent actions**

	EQU	STR	GEO
Total horizontal earth force Fsx=	54.54	43.15	54.54 kN/m
Total vertical earth force Fsy=	17.20	13.60	17.20 kN/m
Total moment of earth force Ms =	74.56	58.99	74.56 kNm/m

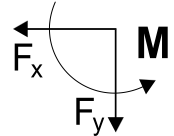

**1.5. Computation of passive earth pressure (Rankine theory)**

**1.5.1. Wall part from y=2.200 m to y=4.100 m, Hs=1.900 m**

Top point A x= 1.800 m y= 2.200 m  
 Bottom point B x= 1.800 m y= 4.100 m

**Soil properties**

Soil type : Dense sand	
Unit weight of soil	=18.00 kN/m <sup>3</sup>
Unit weight of soil (saturated)	s=20.00 kN/m <sup>3</sup>
Unit weight of water	w=10.00 kN/m <sup>3</sup>
Angle of shearing resistance of ground	=30.00°
Cohesion of ground	c=0.000 N/mm <sup>2</sup>
Slope angle of ground surface	= 0.00°
Earth pressure on vertical surface	= 0.00°
Angle of shear resist. between ground-wall	= 0.00°

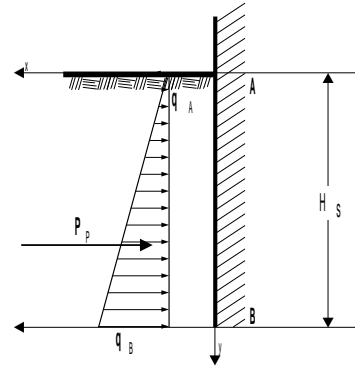

**Earth pressure according to Coulomb theory**

	EQU	STR	GEO
Angle of rupture plane =45°- /2	= 33.00	30.00	33.00°
Coefficient of passive earth pressure Kp=	2.371	3.000	2.371
Earth pressure q(y)=qA+ ·y·Kp			

$$K_p = \frac{\cos^2(+)}{\cos^2(-) \cos(-) \left[ 1 - \sqrt{\frac{\sin(+)\sin(+)}{\cos(-)\cos(-)}} \right]^2}$$

**Permanent actions**

	EQU	STR	GEO
Earth pressure at the top (y=yA)	qA= 0.00	0.00	0.00 kN/m <sup>2</sup>
Earth pressure at the bottom (y=yA+ 1.90m)	qB=-81.09-102.60	-81.09	-81.09 kN/m <sup>2</sup>
Earth force Pa=½(qA+qB)H	Pp= 77.04	97.47	77.04 kN/m
Angle of earth force	= 0.00	0.00	0.00 °
Earth force in x direction	Ppx=-77.04	-97.47	-77.04 kN/m
Earth force in y direction	Ppy= 0.00	0.00	0.00 kN/m
Moment of earth force at top point (x=0,y=0)	M =267.10 337.93 267.10 kNm/m		
Point of application of earth force	x= 1.800 m, y= 3.467 m		

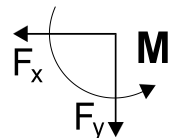

**Total forces and moments**

Forces and moments at bottom point B (x=1.800 m, y=4.100 m)

**Permanent actions**

	EQU	STR	GEO
Total horizontal earth force $F_{sx}$	-77.04	-97.47	-77.04 kN/m
Total vertical earth force $F_{sy}$	0.00	0.00	0.00 kN/m
Total moment of earth force $M_s$	-48.77	-61.70	-48.77 kNm/m

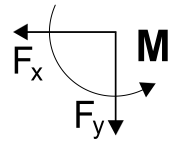

**1.6. Checks of wall stability (EQU)**

**1.6.1. Forces (driving and resisting) on the wall (EQU)**

Action		y1 - y2	Fx [kN/m]	Fy [kN/m]	x [m]	y [m]
Active earth pressure	Pa	0.00- 4.10	54.54	17.20	0.000	2.733
Passive earth pressure	Pp	2.20- 4.10	-77.04	0.00	1.800	3.467
Wall weight	W		0.00	61.00	0.446	2.640
Backfill weight	Ws		0.00	12.96	-0.100	1.800

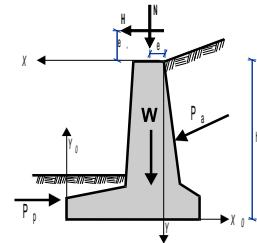

**1.6.2. Check of soil bearing capacity (EQU)**

(EC7 EN1997-1-1:2004, §6.5.2)

**Check for 0.90x(self weight+top vertical dead load)+0.00x(top vertical live load)**

Action	( )	y1 - y2	Fx [kN/m]	Fy [kN/m]	xo [m]	yo [m]	M [kNm/m]
Active earth pressure	Pax1.10	0.00- 4.10	59.99	18.92	1.800	1.367	47.96
Wall weight	W x0.90		0.00	54.90	1.354	1.460	-74.33
Backfill weight	Wsx0.90		0.00	11.66	1.900	2.300	-22.16
			Sum=	85.48			-48.53

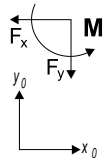

Sum of vertical forces = 85.48 kN/m

Sum of moments at front toe = -48.53 kNm/m

Sum of moments at middle of base = 36.95 kNm/m

Eccentricity  $ec=36.95/85.48=0.432m$ ,  $ec>2.000/6=0.333m$

Soil pressure  $q=0.100$  N/mm<sup>2</sup>  $Bq=1.703$  m

Effective footing  $L=2.000-2x0.432= 1.135$  m

Soil bearing capacity  $Rd=L \cdot qu / M=1.135x(1000x0.18)/1.40= 145.93$  kN/m

Bearing resistance check  $Vd=85.48 < Rd=145.93$  kN/m, Check is verified

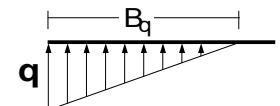

(EC7 Annex D)

(EC7 Eq.2.2, Eq.6.1)

**Check for 1.10x(self weight+top vertical dead load)+1.50x(top vertical live load)**

Action	( )	y1 - y2	Fx [kN/m]	Fy [kN/m]	xo [m]	yo [m]	M [kNm/m]
Active earth pressure	Pax1.10	0.00- 4.10	59.99	18.92	1.800	1.367	47.96
Wall weight	W x1.10		0.00	67.10	1.354	1.460	-90.85
Backfill weight	Wsx1.10		0.00	14.26	1.900	2.300	-27.08
			Sum=	100.28			-69.97

Sum of vertical forces = 100.28 kN/m

Sum of moments at front toe = -69.97 kNm/m

Sum of moments at middle of base = 30.31 kNm/m

Eccentricity  $ec=30.31/100.28=0.302m$ ,  $ec \leq 2.000/6=0.333m$

Soil pressure  $q1=0.096$  N/mm<sup>2</sup>  $q2=0.005$  N/mm<sup>2</sup>

Effective footing  $L=2.000-2x0.302= 1.395$  m

Soil bearing capacity  $Rd=L \cdot qu / M=1.395x(1000x0.18)/1.40= 179.36$  kN/m

Bearing resistance check  $Vd=100.28 < Rd=179.36$  kN/m, Check is verified

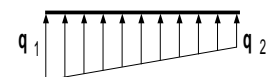

(EC7 Annex D)

(EC7 Eq.2.2, Eq.6.1)

**1.6.3. Failure check due to overturning (EQU)**

(EC7 EN1997-1-1:2004, §9.7.4)

Overturning with respect to the toe ( $x_0=0, y_0=0$ ) ( $x=1.800, y=4.100$  m)

Action	( )	y1 - y2	Fx [kN/m]	Fy [kN/m]	xo [m]	yo [m]	Mo+ [kNm/m]	Mo- [kNm/m]
Active earth pressure	Pax1.10	0.00- 4.10	59.99	18.92	1.800	1.367	82.02	34.06
Wall weight	W x0.90		0.00	54.90	1.354	1.460	0.00	74.33
Backfill weight	Wsx0.90		0.00	11.66	1.900	2.300	0.00	22.16
Sum=							82.02	130.55

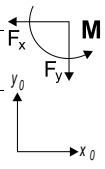

Sum of overturning moments = 82.02 kNm/m  
 Sum of moments resisting overturning = 130.55 kNm/m  
 Overturning check  $M_{ed}=82.02 < M_{rd}=130.55$  kNm/m, Check is verified

**1.6.4. Failure check against sliding (EQU)**

(EC7 EN1997-1-1:2004, §9.7.3, §6.5.3)

Action	( )	y1 - y2	Fx+ [kN/m]	Fx- [kN/m]	Fy [kN/m]
Active earth pressure	Pax1.10	0.00- 4.10	59.99	0.00	18.92
Passive earth pressure	Ppx0.90	2.20- 4.10	0.00	69.34	0.00
Wall weight	W x0.90		0.00	0.00	54.90
Backfill weight	Wsx0.90		0.00	0.00	11.66
Sum=			59.99	69.34	85.48

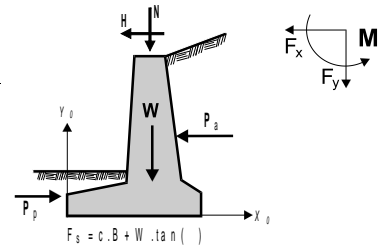

Soil friction  $R_d = V_d \cdot \tan / M = 85.48 \cdot \tan(25.00^\circ) / 1.25 = 31.89$  kN/m  
 (resisting forces from effective cohesion are neglected) (EC7 §6.5.3. 10)  
 Sum of driving forces = 59.99 kN/m  
 Sum of resisting forces (69.34+31.89) = 101.23 kN/m  
 Sliding resistance check  $H_d=59.99 < R_d=101.23$  kN/m, Check is verified

**1.7. Checks of wall stability (STR)**

**1.7.1. Forces (driving and resisting) on the wall (STR)**

Action		y1 - y2	Fx [kN/m]	Fy [kN/m]	x [m]	y [m]
Active earth pressure	Pa	0.00- 4.10	43.15	13.60	0.000	2.733
Passive earth pressure	Pp	2.20- 4.10	-97.47	0.00	1.800	3.467
Wall weight	W		0.00	61.00	0.446	2.640
Backfill weight	Ws		0.00	12.96	-0.100	1.800

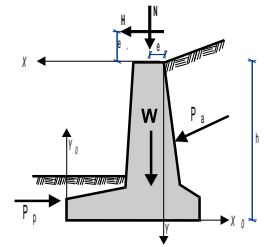

**1.7.2. Check of soil bearing capacity (STR)**

(EC7 EN1997-1-1:2004, §6.5.2)

Check for  $1.00 \times (\text{self weight} + \text{top vertical dead load}) + 0.00 \times (\text{top vertical live load})$

Action	( )	y1 - y2	Fx [kN/m]	Fy [kN/m]	xo [m]	yo [m]	M [kNm/m]	
Active earth pressure	Pax1.35	0.00- 4.10	58.25	18.36	1.800	1.367	46.59	
Wall weight	W x1.00		0.00	61.00	1.354	1.460	-82.59	
Backfill weight	Wsx1.00		0.00	12.96	1.900	2.300	-24.62	
Sum=							92.32	-60.62

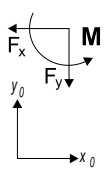

Sum of vertical forces = 92.32 kN/m  
 Sum of moments at front toe = -60.62 kNm/m  
 Sum of moments at middle of base = 31.70 kNm/m  
 Eccentricity  $ec = 31.70 / 92.32 = 0.343$  m,  $ec > 2.000 / 6 = 0.333$  m  
 Soil pressure  $q = 0.094$  N/mm<sup>2</sup>  $B_q = 1.970$  m  
 Effective footing  $L = 2.000 - 2 \times 0.343 = 1.313$  m  
 Soil bearing capacity  $R_d = L \cdot q_u / M = 1.313 \times (1000 \times 0.18) / 1.00 = 236.34$  kN/m  
 Bearing resistance check  $V_d = 92.32 < R_d = 236.34$  kN/m, Check is verified

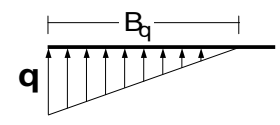

(EC7 Annex D)

(EC7 Eq.2.2, Eq.6.1)

**Check for 1.35x(self weight+top vertical dead load)+1.50x(top vertical live load)**

Action	( )	y1 - y2	Fx [kN/m]	Fy [kN/m]	xo [m]	yo [m]	M [kNm/m]
Active earth pressure	Pax1.35	0.00- 4.10	58.25	18.36	1.800	1.367	46.59
Wall weight	W x1.35		0.00	82.35	1.354	1.460	-111.50
Backfill weight	Wsx1.35		0.00	17.50	1.900	2.300	-33.24
			Sum=	118.21			-98.15

Sum of vertical forces = 118.21 kN/m  
 Sum of moments at front toe = -98.15 kNm/m  
 Sum of moments at middle of base = 20.06 kNm/m  
 Eccentricity  $ec=20.06/118.21=0.170m$ ,  $ec \leq 2.000/6=0.333m$   
 Soil pressure  $q_1=0.089 \text{ N/mm}^2$   $q_2=0.029 \text{ N/mm}^2$   
 Effective footing  $L=2.000-2 \times 0.170= 1.661 \text{ m}$   
 Soil bearing capacity  $Rd=L \cdot qu / M=1.661 \times (1000 \times 0.18) / 1.00= 298.98 \text{ kN/m}$   
 Bearing resistance check  $Vd=118.21 < Rd=298.98 \text{ kN/m}$ , Check is verified

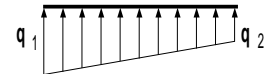

(EC7 Annex D)

(EC7 Eq.2.2, Eq.6.1)

**1.7.3. Failure check due to overturning (STR)**

(EC7 EN1997-1-1:2004, §9.7.4)

Overturning with respect to the toe ( $x_0=0, y_0=0$ ) ( $x=1.800, y=4.100 \text{ m}$ )

Action	( )	y1 - y2	Fx [kN/m]	Fy [kN/m]	xo [m]	yo [m]	Mo+ [kNm/m]	Mo- [kNm/m]
Active earth pressure	Pax1.35	0.00- 4.10	58.25	18.36	1.800	1.367	79.64	33.05
Wall weight	W x1.00		0.00	61.00	1.354	1.460	0.00	82.59
Backfill weight	Wsx1.00		0.00	12.96	1.900	2.300	0.00	24.62
			Sum=				79.64	140.26

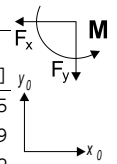

Sum of overturning moments = 79.64 kNm/m  
 Sum of moments resisting overturning = 140.26 kNm/m  
 Overturning check  $Med=79.64 < Mrd=140.26 \text{ kNm/m}$ , Check is verified

**1.7.4. Failure check against sliding (STR)**

(EC7 EN1997-1-1:2004, §9.7.3, §6.5.3)

Action	( )	y1 - y2	Fx+ [kN/m]	Fx- [kN/m]	Fy [kN/m]	
Active earth pressure	Pax1.35	0.00- 4.10	58.25	0.00	18.36	
Passive earth pressure	Ppx1.00	2.20- 4.10	0.00	97.47	0.00	
Wall weight	W x1.00		0.00	0.00	61.00	
Backfill weight	Wsx1.00		0.00	0.00	12.96	
			Sum=	58.25	97.47	92.32

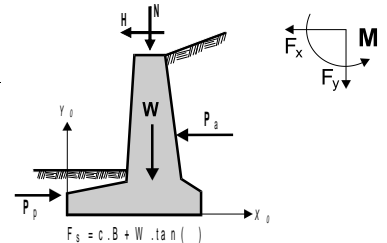

Soil friction  $Rd=Vd \cdot \tan / M= 92.32 \times \tan(25.00^\circ) / 1.00= 43.05 \text{ kN/m}$   
 (resisting forces from effective cohesion are neglected)  
 Sum of driving forces = 58.25 kN/m  
 Sum of resisting forces ( $97.47+43.05$ ) = 140.52 kN/m  
 Sliding resistance check  $Hd=58.25 < Rd=140.52 \text{ kN/m}$ , Check is verified

(EC7 §6.5.3. 10)

**1.8. Checks of wall stability (GEO)**

**1.8.1. Forces (driving and resisting) on the wall (GEO)**

Action		y1 - y2	Fx [kN/m]	Fy [kN/m]	x [m]	y [m]
Active earth pressure	Pa	0.00- 4.10	54.54	17.20	0.000	2.733
Passive earth pressure	Pp	2.20- 4.10	-77.04	0.00	1.800	3.467
Wall weight	W		0.00	61.00	0.446	2.640
Backfill weight	Ws		0.00	12.96	-0.100	1.800

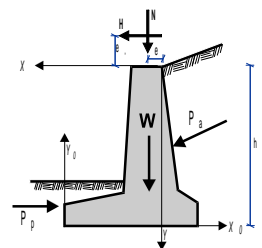

**1.8.2. Check of soil bearing capacity (GEO)**

(EC7 EN1997-1-1:2004, §6.5.2)

Check for 1.00x(self weight+top vertical dead load)+0.00x(top vertical live load)

Action	( )	y1 - y2	Fx [kN/m]	Fy [kN/m]	xo [m]	yo [m]	M [kNm/m]
Active earth pressure	Pax1.00	0.00- 4.10	54.54	17.20	1.800	1.367	43.60
Wall weight	W x1.00		0.00	61.00	1.354	1.460	-82.59
Backfill weight	Wsx1.00		0.00	12.96	1.900	2.300	-24.62
			Sum=	91.16			-63.61

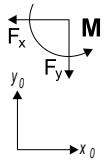

Sum of vertical forces = 91.16 kN/m  
 Sum of moments at front toe = -63.61 kNm/m  
 Sum of moments at middle of base = 27.55 kNm/m  
 Eccentricity  $ec=27.55/91.16=0.302m$ ,  $ec \leq 2.000/6=0.333m$   
 Soil pressure  $q1=0.087 \text{ N/mm}^2$   $q2=0.004 \text{ N/mm}^2$   
 Effective footing  $L=2.000-2x0.302= 1.396 \text{ m}$   
 Soil bearing capacity  $Rd=L \cdot qu / M=1.396x(1000x0.18)/1.40= 179.49 \text{ kN/m}$   
 Bearing resistance check  $Vd=91.16 < Rd=179.49 \text{ kN/m}$ , Check is verified

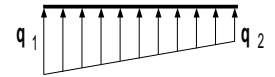

(EC7 Annex D)

(EC7 Eq.2.2, Eq.6.1)

Check for 1.00x(self weight+top vertical dead load)+1.30x(top vertical live load)

Action	( )	y1 - y2	Fx [kN/m]	Fy [kN/m]	xo [m]	yo [m]	M [kNm/m]
Active earth pressure	Pax1.00	0.00- 4.10	54.54	17.20	1.800	1.367	43.60
Wall weight	W x1.00		0.00	61.00	1.354	1.460	-82.59
Backfill weight	Wsx1.00		0.00	12.96	1.900	2.300	-24.62
			Sum=	91.16			-63.61

Sum of vertical forces = 91.16 kN/m  
 Sum of moments at front toe = -63.61 kNm/m  
 Sum of moments at middle of base = 27.55 kNm/m  
 Eccentricity  $ec=27.55/91.16=0.302m$ ,  $ec \leq 2.000/6=0.333m$   
 Soil pressure  $q1=0.087 \text{ N/mm}^2$   $q2=0.004 \text{ N/mm}^2$   
 Effective footing  $L=2.000-2x0.302= 1.396 \text{ m}$   
 Soil bearing capacity  $Rd=L \cdot qu / M=1.396x(1000x0.18)/1.40= 179.49 \text{ kN/m}$   
 Bearing resistance check  $Vd=91.16 < Rd=179.49 \text{ kN/m}$ , Check is verified

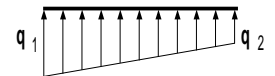

(EC7 Annex D)

(EC7 Eq.2.2, Eq.6.1)

**1.8.3. Failure check due to overturning (GEO)**

(EC7 EN1997-1-1:2004, §9.7.4)

Overturning with respect to the toe ( $xo=0, yo=0$ ) ( $x=1.800, y=4.100 \text{ m}$ )

Action	( )	y1 - y2	Fx [kN/m]	Fy [kN/m]	xo [m]	yo [m]	Mo+ [kNm/m]	Mo- [kNm/m]
Active earth pressure	Pax1.00	0.00- 4.10	54.54	17.20	1.800	1.367	74.56	30.96
Wall weight	W x1.00		0.00	61.00	1.354	1.460	0.00	82.59
Backfill weight	Wsx1.00		0.00	12.96	1.900	2.300	0.00	24.62
							Sum=	74.56 138.17

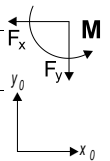

Sum of overturning moments = 74.56 kNm/m  
 Sum of moments resisting overturning = 138.17 kNm/m  
 Overturning check  $Med=74.56 < Mrd=138.17 \text{ kNm/m}$ , Check is verified

**1.8.4. Failure check against sliding (GEO)**

(EC7 EN1997-1-1:2004, §9.7.3, §6.5.3)

Action	( )	y1 - y2	Fx+ [kN/m]	Fx- [kN/m]	Fy [kN/m]
Active earth pressure	Pax1.00	0.00- 4.10	54.54	0.00	17.20
Passive earth pressure	Ppx1.00	2.20- 4.10	0.00	77.04	0.00
Wall weight	W x1.00		0.00	0.00	61.00
Backfill weight	Wsx1.00		0.00	0.00	12.96
			Sum=	54.54 77.04	91.16

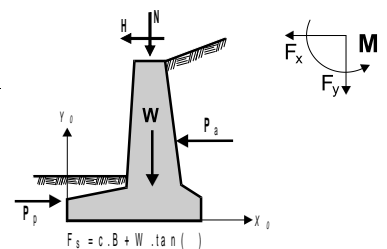

Soil friction  $R_d = V_d \cdot \tan / M = 91.16 \times \tan(25.00^\circ) / 1.25 = 34.01 \text{ kN/m}$   
 (resisting forces from effective cohesion are neglected) (EC7 §6.5.3. 10)  
 Sum of driving forces = 54.54 kN/m  
 Sum of resisting forces (77.04+34.01) = 111.05 kN/m  
 Sliding resistance check  $H_d = 54.54 < R_d = 111.05 \text{ kN/m}$ , Check is verified

**1.9. Design of wall steam**

(EC2 EN1992-1-1:2004)

**1.9.1. Loading 1.35x(permanent unfavourable)+1.00x(permanent favourable)+1.50x(variable unfav.)**

Forces (at cross section centroid) at wall steam

y [m]	h [m]	Fx [kN/m]	Fy [kN/m]	M [kNm/m]
0.50	0.400	0.86	5.27	0.09
1.00	0.400	3.47	11.09	0.94
1.50	0.400	7.79	17.46	3.40
2.00	0.400	13.85	24.37	8.36
2.50	0.400	21.65	31.83	16.67
3.00	0.400	31.19	39.83	29.22
3.60	0.400	44.91	50.16	51.06

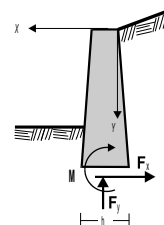

**1.9.2. Design of wall steam in bending**

(EC2 §9.6, §6.1)

Concrete-Steel class: C25/30-B500B, Concrete cover:  $C_{nom} = 25 \text{ mm}$  (§3, §4.4.1.1)  
 Vertical reinforcement minimum:  $0.26(f_{ctm}/f_{yk})d$ ,  $0.0013d$ ,  $0.0020A_c$ , maximum:  $0.04A_c$  (EC2 §9.6.2)

y [m]	Med [kN/m]	Ned [kN]	d [mm]	Kd	x/d	c/ s	Ks	As [cm <sup>2</sup> /m]	min vyzt. [cm <sup>2</sup> /m]
0.50	0.09	-5.27	370	37.18	0.01	0.1/20.0	2.30	0.00	( 4.00)
1.00	0.94	-11.09	370	22.00	0.01	0.2/20.0	2.31	0.00	( 4.00)
1.50	3.40	-17.46	370	14.67	0.02	0.4/20.0	2.31	0.00	( 4.00)
2.00	8.36	-24.37	370	10.46	0.03	0.5/20.0	2.32	0.22	( 5.00)
2.50	16.67	-31.83	370	7.87	0.04	0.7/20.0	2.33	0.66	( 5.00)
3.00	29.22	-39.83	370	6.17	0.05	1.0/20.0	2.34	1.36	( 5.00)
3.60	51.06	-50.16	370	4.79	0.06	1.3/20.0	2.35	2.63	( 5.00)

**1.9.3. Reinforcement of wall steam**

Reinforcement at back steam face  $\varnothing 10/15.5$  ( 5.06cm<sup>2</sup>/m)  
 Secondary transverse reinforcement  $\varnothing 8/40.0$  ( 1.26cm<sup>2</sup>/m)  
 Reinforcement at front steam face  $\varnothing 10/19.5$  ( 4.03cm<sup>2</sup>/m)  
 Secondary transverse reinforcement  $\varnothing 8/40.0$  ( 1.26cm<sup>2</sup>/m)

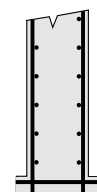

**1.9.4. Anchorage of wall steam reinforcement**

(EC2 §8.4)

Basic required anchorage length (EC2 Eq.8.3)  
 $l_{b,rqd} = (\varnothing/4) (s_d/f_{bd}) = (10/4) \times (226/1.61) = 351 \text{ mm}$   
 $s_d = 435.00 \times 263 / 506 = 226 \text{ MPa}$   $f_{bd} = 2.25 \times 0.70 \times (f_{ctk} 0.05 / c) = 1.61 \text{ MPa}$  (EC2 §8.4.2)  
 Design anchorage length  $l_{bd} = 1.00 \times 351 = 351 \text{ mm}$ ,  $C_{nom} = 25 \text{ mm} < 3\varnothing = 30 \text{ mm}$  (EC2 §8.4.4, T.8.2)  
 Minimum anchorage length  $l_{b,min} = \max(0.30 l_{b,rqd}, 10\varnothing, 100 \text{ mm}) = 105 \text{ mm}$   
 Necessary bend 100mm at lower bar end for anchorage

**1.9.5. Shear check of wall steam**

(EC2 EN1992-1-1:2004, §6.2.2)

Concrete-Steel class: C25/30-B500B, Concrete cover:  $C_{nom} = 25 \text{ mm}$  (§3, §4.4.1.1)  
 The earth pressure load variation is linear, so the variation of shear force is parabolic. The variation of steam cross section is linear.  
 The most unfavourable place for shear check is the base of the steam.



Ved=36.45 kN/m, Ned=-43.79 kN/m  
 Shear capacity without shear reinforcement Vrdc (EC2 §6.2.2)  
 $Vrdc = [Crdc \cdot k \cdot (100 \cdot l \cdot f_{ck})^{0.33} + k_1 \cdot c_p] \cdot b_w \cdot d$  (EC2 Eq.6.2.a)  
 $Vrdc \geq (v_{min} + k_1 \cdot c_p) \cdot b_w \cdot d$  (EC2 Eq.6.2.b)  
 Crdc=0.18/ c=0.18/1.50=0.120, fck=25.00MPa ,bw=1000mm, d=370mm  
 $k = 1 + \sqrt{200/d} \leq 2$ , k=1.74, k1=0.15  
 $l = A_{s1} / (b_w \cdot d) = 506 / (1000 \times 370) = 0.0014$   
 $c_p = N_{ed} / A_c = 1000 \times 43.79 / 400000 = 0.11 \text{ N/mm}^2$   
 $v_{min} = 0.035 \cdot k^{1.50} \cdot \sqrt{f_{ck}} = 0.40 \text{ N/mm}^2$  (EC2 Eq.6.3N)  
 $Vr_{d,c(min)} = 0.001 \times (0.40 + 0.15 \times 0.11) \times 1000 \times 370 = 154.11 \text{ kN/m}$   
 $Vr_{dc} = 0.001 \times [0.120 \times 1.74 \times (0.14 \times 25.00)^{0.33} + 0.15 \times 0.11] \times 1000 \times 370 = 123.40$ , Vrdc=Vrdc(min)=154.11kN/m  
 Ved=36.45 kN/m <= Vrdc=154.11 kN/m, shear OK

**1.10. Design of wall footing and reinforcement**

(EC2 EN1992-1-1:2004)

**1.10.1. Design of front toe x=1.800 m to x=0.400 m**

Sum of vertical forces = 118.21 kN/m  
 Sum of moments at middle of base = 20.06 kNm/m  
 $q_1 = 0.089 \text{ N/mm}^2$ ,  $q_2 = 0.047 \text{ N/mm}^2$ , w= 1.400 m  
 pressure from self weight  $q_3 = 0.013 \text{ N/mm}^2$   
 $M = 60.91 \text{ kNm/m}$ ,  $V = 77.18 \text{ kN/m}$   
 $V$  at distance d=425mm from the face of the steam = 60.02 kN/m  
 $M_{ed} = 60.91 \text{ kNm/m}$ ,  $V_{sd} = 60.02 \text{ kN/m}$

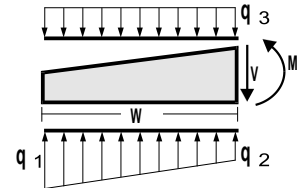

**1.10.2. Design of wall footing in bending**

(EC2 EN1992-1-1:2004, §6.1)

Concrete-Steel class: C25/30-B500B, Concrete cover: Cnom=75 mm (§3, §4.4.1.1)  
 $M_{ed} = 60.91 \text{ kNm/m}$ , d=417mm, Kd= 5.34 x/d=0.05 c2/ s1=-1.1/20.0 ks=2.34, **As= 3.42cm<sup>2</sup>/m**  
 Minimum reinforcement  $A_{s \geq} = 0.26bd \cdot f_{ctm} / f_{yk}$  (As= 5.64cm<sup>2</sup>/m) (EC2 §9.3.1)  
 Minimum reinforcement Ø16/35.5 ( 5.66cm<sup>2</sup>/m)

**1.10.3. Reinforcement of wall footing**

**Footing reinforcement at bottom** Ø16/35.5 ( 5.66cm<sup>2</sup>/m)  
**Secondary transverse reinforcement** Ø16/40.0 ( 5.02cm<sup>2</sup>/m)

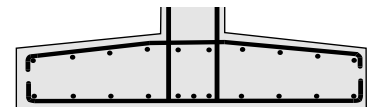

**1.10.4. Anchorage of footing reinforcement**

(EC2 EN1992-1-1:2004, §9.8.2.2, §8.4)

$x = h/2 = 0.250 \text{ m}$ ,  $R = 1000 \times 0.089 \times 0.250 = 22.25 \text{ kN/m}$   
 $e = 0.15b = 0.060 \text{ m}$   $z_e = 1.335 \text{ m}$ ,  $z_i = 0.900d = 0.375 \text{ m}$   
 $F_s = R \cdot z_e / z_i = 22.25 \times 1.335 / 0.375 = 79.15 \text{ kN/m}$   
 $s_d = F_s / A_s = 1000 \times 79.15 / 566 = 140 \text{ MPa}$   
 Basic required anchorage length (EC2 Eq.8.3)  
 $l_{b,rqd} = (\sigma_s / 4) \cdot (s_d / f_{bd}) = (16/4) \times (140/2.30) = 243 \text{ mm}$   
 $f_{bd} = 2.25 \times 1.00 \times (f_{ctk} \cdot 0.05 / c) = 2.30 \text{ MPa}$  (EC2 §8.4.2)  
 Design anchorage length (EC2 §8.4.4, T.8.2)  
 $l_{bd} = 0.70 \times 243 = 170 \text{ mm}$ , Cnom=75mm > 3Ø=48mm  
 Minimum anchorage length  $l_{b,min} = \max(0.30l_{b,rqd}, 10\text{Ø}, 100 \text{ mm}) = 160 \text{ mm}$   
 Necessary anchorage length of longitudinal reinforcement  $L_{bd} = 170 \text{ mm} = 0.170 \text{ m}$   
 $l_{bd} = 170 \text{ mm} < (x - C_{nom}) = 175.00$ . Sufficient length is available

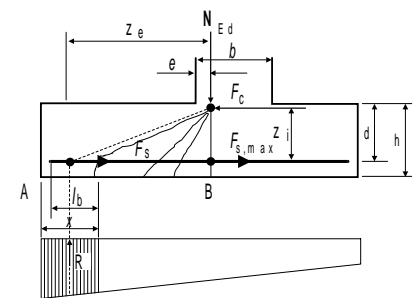

**1.10.5. Design of wall footing for shear and punching shear**

(EC2 EN1992-1-1:2004, §6.2.2)

Concrete-Steel class: C25/30-B500B, Concrete cover:  $C_{nom}=75$  mm (§3, §4.4.1.1)

Punching shear capacity without shear reinforcement  $V_{rdc}$  (EC2 §6.4.4)

$$V_{rdc} = [C_{rdc} \cdot k \cdot (100 \cdot f_{ck})^{0.33} \cdot (2d/a)] \cdot b_w \cdot d \quad (EC2 \text{ Eq.6.50})$$

$$V_{rdc} >= [v_{min} \cdot 2d/a] \cdot b_w \cdot d, \quad d = d_m = 417 \text{ mm}, \quad a = 417 \text{ mm}$$

$$C_{rdc} = 0.18 / c = 0.18 / 1.50 = 0.120, \quad f_{ck} = 25.00 \text{ MPa}, \quad b_w = 1000 \text{ mm}, \quad d = 417 \text{ mm}$$

$$k = 1 + \sqrt{200/d} \leq 2, \quad k = 1.69$$

$$l = A_{s1} / (b_w \cdot d) = 566 / (1000 \times 417) = 0.0014$$

$$v_{min} = 0.035 \cdot k^{1.50} \cdot \sqrt{f_{ck}} = 0.38 \text{ N/mm}^2 \quad (EC2 \text{ Eq.6.3N})$$

$$V_{rd,c(min)} = 0.0014 \times (0.38 \times 2 \times 417 / 417) \times 1000 \times 417 = 316.92 \text{ kN/m}$$

$$V_{rdc} = 0.0014 \times [0.120 \times 1.69 \times (0.14 \times 25.00)^{0.33} \times 2 \times 417 / 417] \times 1000 \times 417 = 256.80, \quad V_{rdc} = V_{rdc(min)} = 316.92 \text{ kN/m}$$

$$V_{ed} = 60.02 \text{ kN/m} \leq V_{rdc} = 316.92 \text{ kN/m}, \text{ shear and punching shear OK}$$

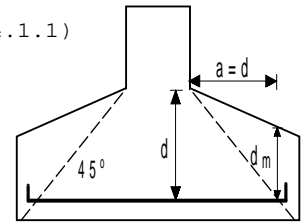

**1.11. Material estimate**

Concrete per meter of wall length 2.440 m<sup>3</sup>/m

Reinforcing steel per meter of wall 69.137 kg/m

Total concrete of wall 6.000x 2.440= 14.640 m<sup>3</sup>

Total reinforcing steel of wall 6.000x 69.137= 414.820 kg

**1.12. Reinforcing bar schedule**

Num	type	reinforcing bar [mm]	items	∅	g/m [kg/m]	length [m]	weight [kg]
1	①	100  100	39	10	0.617	4.170	100.34
2	④	100  100	31	10	0.617	4.170	79.76
3	⑨	6000	20	8	0.395	6.000	47.40
4	⑦	1830	17	16	1.580	1.830	49.15
5	⑧	1830	15	16	1.580	1.830	43.37
6	⑩	6000	10	16	1.580	6.000	94.80

Total weight [kg]

414.82

